

## Guide for the use of HANS® in international motor sport



The HANS® (Head And Neck Support) head restraint

---

Issue: 01/07/2007

---

## 1. Choosing a HANS®

HANS® devices exist not only in different sizes but with different angles between the yoke and collar. The manufacturer or supplier should be consulted on the best model for the motor sport activity and car concerned.

## 2. Safety harness with HANS®

**2.1** The safety belts must be homologated to the FIA standards and it is strongly recommended to use only 6 point harnesses homologated to FIA standard 8853/98; these must NOT feature energy conversion in the shoulder straps (asm® - Anti submarining) EXCEPT if 4-point, in which case asm® may be of benefit.

Harness models are homologated with the standard shoulder strap width of 75mm, as well as a special width of 50mm marked "for HANS® use only": either model may be used.

**2.2** The length adjustment device of the shoulder belt shall be positioned on the HANS® yoke with the upper edge not more than 70mm from the lower edge of the HANS® yoke as shown in Figure 1 (this does not apply in the case of the double shoulder belt system described in point 2.5).

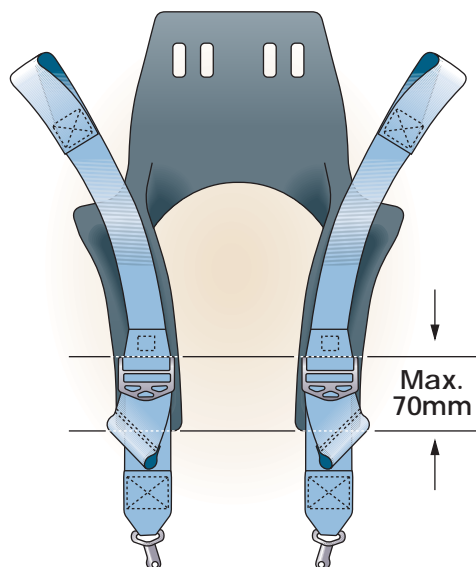

Figure 1. Correct position of shoulder strap length adjustment device on HANS® yoke

**2.3** The shoulder strap anchorage points on the car shall be symmetrical about the centre line of the driver's seat. When viewed from above, the angle between the belts shall be approximately 20°-25° as shown in Figure 2.

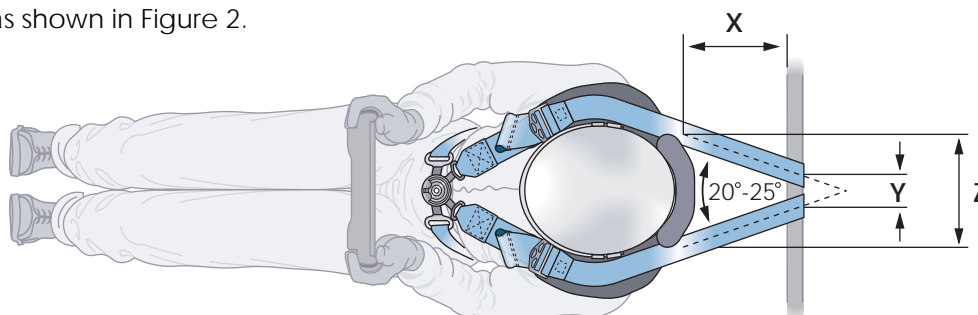

Figure 2. Position of shoulder belt anchorage points to achieve desired belt angle (plan view)

This can be achieved with reference to the values in Tables 1 to 4 which have been calculated based on 75mm wide belts (values for 50mm wide belts are shown in brackets) and four HANS® collar sizes: 120mm, 140mm, 160mm and 180mm. Negative values indicate that the belts are crossed. These values should be closely respected, but a tolerance of +/-20 mm would be acceptable. Belt movement in the anchorages should be taken into account.

The values in red (underlined) denote that theoretical separation is less than belt width. In this case it is recommended that the belts are installed side by side to avoid any overlap; hence the actual separation shall be equal to the belt width. If the value is negative, the belts should be crossed.

*NB: shoulder straps over 200mm long are permitted but not recommended.*

**Table 1: Reference values for 120mm HANS Collar**

Z HANS collar width (mm)	120							
X HANS to belt anchorage (mm)	100	200	300	400	500	600	700	800
Y belt anchorage to separation (mm)	135 (110)	95 (70)	<u>55</u> <u>(30)</u>	<u>15</u> <u>(-10)</u>	<u>-25</u> <u>(-50)</u>	<u>-65</u> <u>(-90)</u>	-105 (-130)	-145 (-170)

**Table 2: Reference values for 140mm HANS Collar**

Z HANS collar width (mm)	140							
X HANS to belt anchorage (mm)	100	200	300	400	500	600	700	800
Y belt anchorage to separation (mm)	155 (130)	115 (90)	75 (50)	<u>35</u> <u>(10)</u>	<u>-5</u> <u>(-30)</u>	<u>-45</u> <u>(-70)</u>	-85 (-110)	-125 (-150)

**Table 3: Reference values for 160mm HANS Collar**

Z HANS collar width (mm)	160							
X HANS to belt anchorage (mm)	100	200	300	400	500	600	700	800
Y belt anchorage to separation (mm)	175 (150)	135 (110)	95 (70)	<u>55</u> <u>(30)</u>	<u>15</u> <u>(-10)</u>	<u>-25</u> <u>(-50)</u>	<u>-65</u> <u>(-90)</u>	-105 (-130)

**Table 4: Reference values for 180mm HANS Collar**

Z HANS collar width (mm)	180							
X HANS to belt anchorage (mm)	100	200	300	400	500	600	700	800
Y belt anchorage to separation (mm)	195 (170)	155 (130)	115 (90)	75 (50)	<u>35</u> <u>(10)</u>	<u>-5</u> <u>(-30)</u>	<u>-45</u> <u>(-70)</u>	-85 (-110)

**Definitions for the reference values:**

- dimension Z (mm) = width of the HANS® collar, as shown in Figures 2 and 3
- dimension X (mm) = distance from the rear edge of the HANS®-belt-bearing-surface to the car attachment point (mm) as shown in Figure 2
- dimension Y (mm) = separation of the centres of the two shoulder straps at the car attachment points (mm) as shown in Figure 2

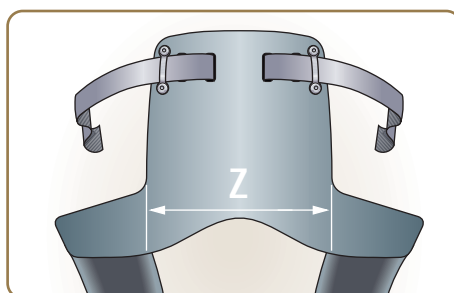

Figure 3. Measurement of HANS collar width

No regulatory value

**2.4** The rear section of the shoulder strap should slope downwards from the uppermost point of contact with the HANS®-belt-bearing-surface to the anchorage point on the car, preferably at about 20° below the horizontal, angles between 0° and 20° being acceptable as shown in Figure 4.

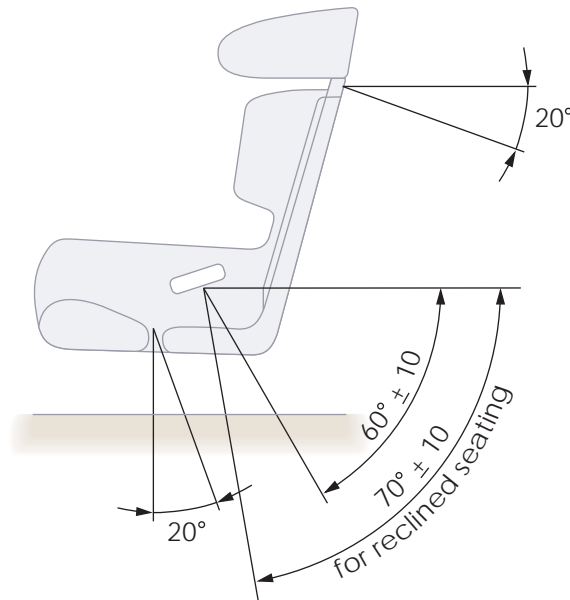

Figure 4. Side view to show recommended belt angles

In accordance with Article 253-6 of Appendix J to the International Sporting Code it is particularly important to prevent any lateral movement of the belt anchorage points by the application of adequate provisions. Screw inserts in conformity with Article 253-6 of Appendix J are recommended.

**2.5** Double shoulder belt system: a safety harness system with two straps on each shoulder is homologated by the FIA and may be used. It provides one **body-belt** that is positioned on the driver's shoulders (beneath the HANS®) and a second **HANS®-belt** that is positioned on the HANS® yokes (as for standard HANS® use). It is important that the HANS®-belt is at least as tight as the body-belt. A drawing of the double belt system is shown in Figure 5.

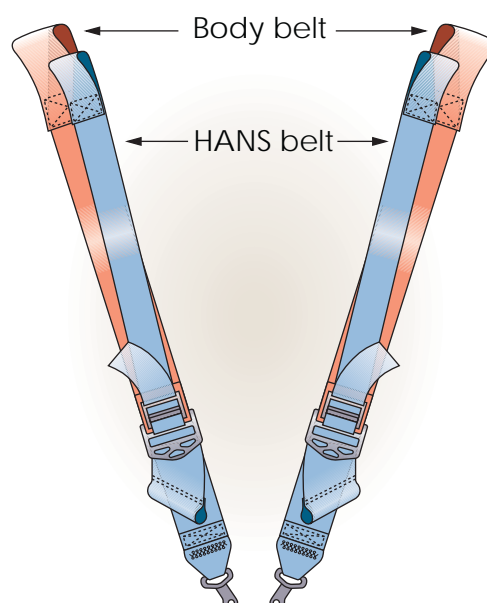

Figure 5. Double shoulder belt system

No regulatory value

For Formula Cars and other cars where the shoulder belt anchorage is less than 200mm behind the rear edge of the HANS®-belt-bearing-surface (ie  $X < 200$  mm), the body-belt anchorage points should be positioned 60mm +/- 15mm below the HANS®-belt anchorage points (see Figure 6).

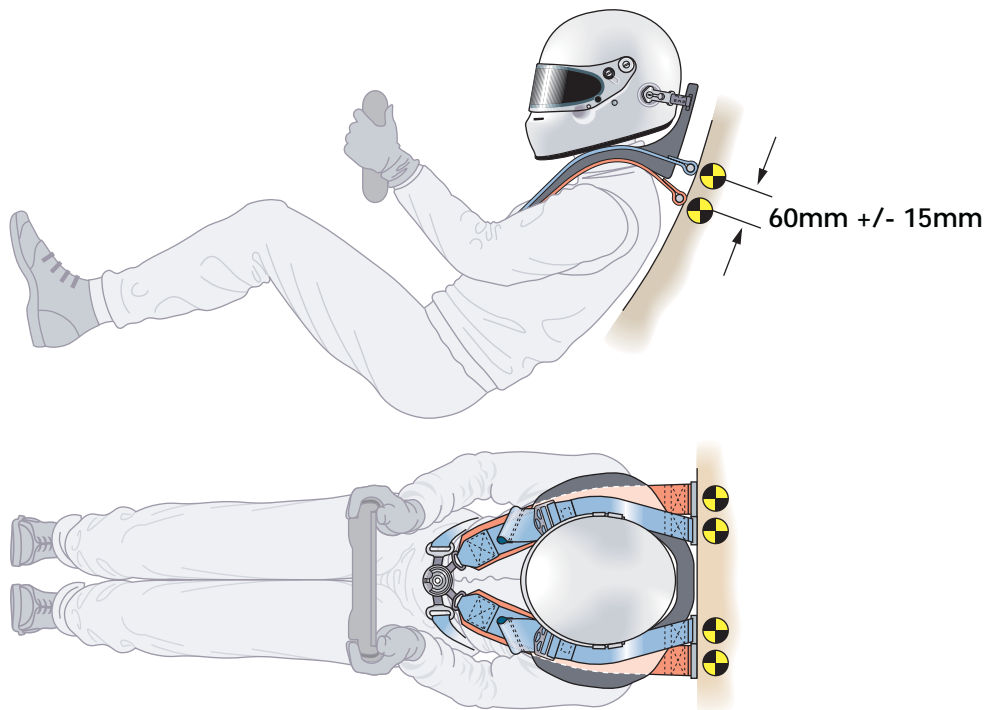

Figure 6. Installation of HANS® double belts in cars where ( $X < 200$ mm)

For closed cars and other cars where the shoulder belt anchorage is more than 200mm behind the rear edge of the HANS®-belt-bearing-surface (ie  $X > 200$  mm), the body-belt anchorage points should be the same height as the HANS®-belt anchorage points (see Figure 7).

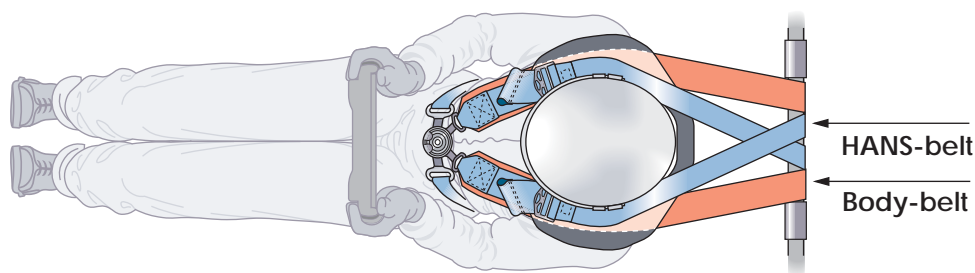

Figure 7. Installation of HANS® double belts in cars where ( $X > 200$ mm)

In **both** cases ( $X < 200$ mm and  $X > 200$ mm), the HANS®-belts should be installed as detailed in sections 2.3 and 2.4.

If the HANS®-belts and body-belts are installed on the same roll cage tube, the HANS®-belts shall respect the dimensions in Tables 1 to 4 and should be attached to the tube inboard of the body-belts, as shown in Figure 7. The body-belts may, exceptionally, be installed with a greater dimension Y if necessary to accommodate this, up to the point of being parallel to each other, but not divergent.

When using double shoulder belts, there MUST be a minimum distance B between the lower edge of the HANS®-yokes and the merging of the two belts where the HANS®-belt is sewn to the body-belt (see figure 8).

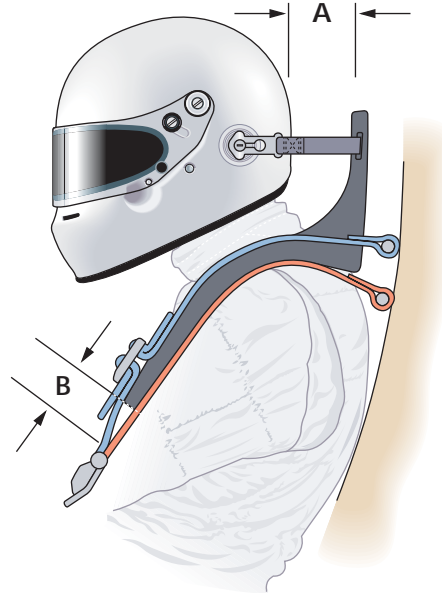

Figure 8. Minimum distance between HANS® yokes and double-shoulder belt merge point

The minimum **distance B** shall be determined as follows:

- the driver shall be seated in the car in the normal driving position, wearing the HANS® and helmet and with the safety harness fastened;
- the driver should lean his/her body and head forward as far as possible - in this position the horizontal distance from the front surface of the HANS®-collar to the rearmost point of the helmet shall be measured (**distance A**);
- **minimum distance B = 100mm – distance A.**

### 3. Preparation of HANS®

**3.1** The upper surface of the HANS®'a8 shall be covered in a high friction rubber to grip the lower surface of the shoulder straps. If the HANS®'a8 is painted (only in conformity with the manufacturer's instructions) it is essential that the rubber is left completely uncovered to ensure that the friction with the shoulder belts is not compromised. Any painted HANS®'a8 shall respect the flame resistance requirement of FIA Standard 8858-2002. The condition of the rubber surface should be monitored – no breakage, ripping, tears or other damage is acceptable. In case of repair, it shall be done strictly in accordance with the manufacturer's instructions.

**3.2** It is recommended that the surface of the HANS®'a8 in contact with the driver's body is padded for comfort. Approved foams, gel-pads and air-pads are permitted and it is recommended that the padding is covered in flame retardant material. The maximum thickness is 15mm. When using air-pads it is recommended that a thin gel-pad is added with strong double sided tape to the lower surface of the HANS®'a8 such that in the event of deflation of the air-pad, there will be some residual comfort padding.

### 4. Headrests and cockpit surrounds with HANS®

In order to ensure compatibility with the rear headrest, sufficient clearance is necessary between the rear of the HANS® and the seatback bulkhead or top of the seat. The minimum necessary is 25mm. Where possible the installation should enable the headrest to be fully compressed by the helmet and HANS® without any interaction with the seatback bulkhead or top of the seat.

## 5. Helmets with HANS®

**5.1** An FIA approved helmet conforming to FIA 8858-2002 or FIA 8860-2004 (or latest revisions) fitted with helmet-tether-anchorages shall be used. Please refer to FIA Technical List 29 for further details.

**5.2** The position of the helmet-tether-anchorages shall comply with FIA 8858-2002. It is strongly recommended to use helmets with helmet-tether-anchorage inserts fitted by the manufacturer as original equipment: these are identified by a glossy silver holographic FIA label as illustrated in figure 9.



Figure 9. Label for identifying helmets originally equipped with HANS® inserts.

**5.3** Original Equipment helmet-anchorage should not be removed for painting the helmet. However, if it is apparent that the helmet-anchorage have been removed, they shall be correctly refitted with thread locking compound.

## 6. Tethers with HANS®

**6.1** The two tethers should be adjusted to the same length.

**6.2** It is not recommended to fit the tethers very short and tight. A nominal length is 150mm. A tolerance of +/- 25mm is acceptable. The length shall be measured from the leading edge of the HANS® collar to the point of connection to the outside of the helmet.

**6.3** The condition of the tethers and clamping brackets and the screws securing them to the back of the HANS® should be closely monitored and they should be replaced if any wear is observed.

## 7. Car evacuation with HANS®

It is essential to practice rapid evacuations from the car with full race equipment fitted (including race attire, steering wheel, radio system and drink system if applicable). This will help to ensure successful emergency evacuation, in the case of an accident. Apertures in which the HANS® collar might catch during evacuation should be filled in where possible.

## 8. HANS® in non-competitive driving

It is unsafe to drive (or co-drive) wearing a HANS® device not attached to a helmet. Therefore whenever a helmet is not worn, for example on rally liaison sections, the HANS® shall be removed also.

## 9. Accident damage

After a heavy impact that involves loading of the HANS®, it is recommended to replace the Helmet and HANS®. The respective manufacturers may be able to provide an inspection service to determine whether the Helmet or HANS® has suffered any damage during less severe impacts.



**Appendix:**

FIA Regulations regarding the use of HANS®

The following regulations, standards and technical lists can be found on:

[www.fia.com](http://www.fia.com) (- FIA Sport – Regulations)

- Appendix L to the International Sporting Code, Chapter III, Article 3
- FIA Standard 8858-2002-HANS® System
- Technical list n° 28 – Material suitable for HANS®
- Technical list n° 29 – List of FIA-approved HANS® devices according to FIA Standard 8858-2002 and compatible helmets
  
- and concerning Safety Belt installation: Appendix J to the International Sporting Code, Article 253-6

The acronym HANS® and its derivative styles is a trademark registered in the US and other countries worldwide to Hubbard/Downing, Inc., dba HANS® Performance Products, Atlanta, Georgia. It is used here with express permission.

The acronym asm® is a registered trademark of SCHROTH Safety Products GmbH.